



SOUTHWEST

STEEL BUILDINGS

Engineered Bolt up • Weld up
Weld up PLUS

Metal Building Components
Accessories & Insulation
Residential Roofing & Trim

From the Owner...

In 2003 Julie and I were blessed with the vision of what has become Southwest Steel Buildings. From the beginning we sought to build our company on Biblical principles and that continues to be our Source as we move forward.

Southwest began as a supply company as a result of not receiving the service we needed out of the suppliers in the market. Born out of that problem was a desire to service the unique needs of contractors. We seek to provide you with quick response time, high service levels, clear communication, and of course, quality components.

Our purpose as a company is to **Honor God, Build Dreams, and Spread Joy**. Part of building dreams is helping our contractors build their dreams. We try to make the process as simple as possible so you can spend your time better serving your customers.

Honoring God means that integrity isn't a facade. It permeates the whole. It's ingrained in the DNA of our company. We aren't perfect, but to the best of our ability we strive to live out the Biblical principles we hold dear.

Spreading joy means that we work hard, but enjoy our work too. We answer the phone with a smile and strive to get you in and out quickly. I've had the experience of waiting three hours to be loaded and that's a joy killer!

We want to do business with people and companies we can add value to. I encourage you to take a look at us and see how we can help you grow your business!

Building What Matters,

Adam Steck

Owner

READY TO GROW YOUR BUSINESS?

Let us help you grow your business with:

- Access to 3D Designer plus online tools
- Quick Accurate Quoting
- Person-to-person Communication

We desire to partner with you rather than just be a vendor. That means we make the process as simple as possible so you can spend more time at the dinner table with your family.

3D DESIGN TOOL



HAVE A CUSTOMER WHO NEEDS TO SEE IT?

Show customers exactly what their building will look like with our easy to use, interactive, Designer.





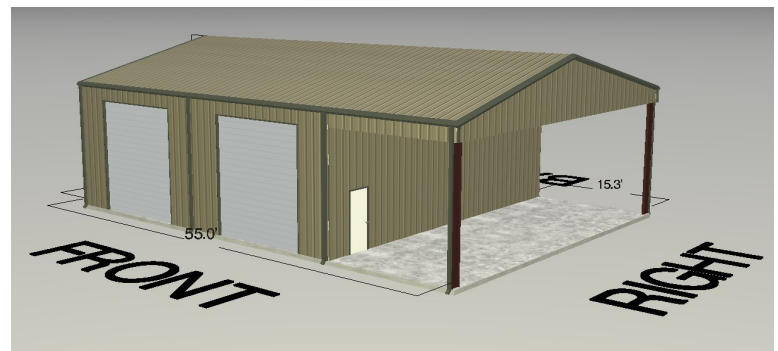
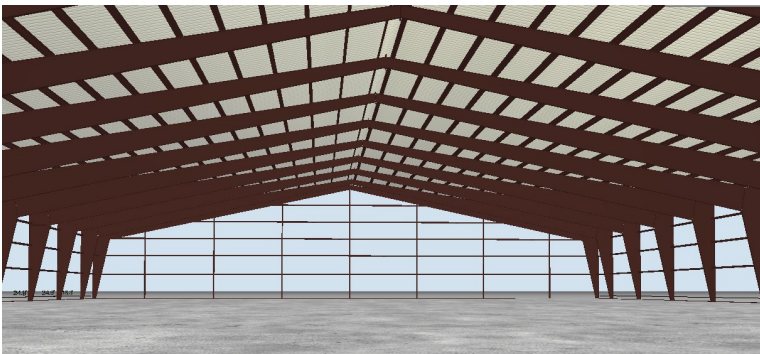

You have the ability to move window and door placements, add porches, see colors and much more!

“I’ve had nothing but compliments when I’ve used the 3D Designer with customers” - M. Culver



SWBuildNet.com

ANYTIME QUOTES. SIMPLE ORDERING. 24/7 ACCESS.

| Line Items | Documents | Custom Drawings | | | | | | |
|---|------------|-----------------|-----|--------|--------|-----------------------------------|-------|------------------|
| Img | Item # | Drw | Pcs | Length | Qty | Description | Color | Status |
|  | RCF261010 | | 9 | 179" | 159.75 | Flat Ridge Cap 10x10 (1.12) | Tan | In Production |
|  | SRT261400 | | 16 | 179" | 284.00 | PBR-Sculptured Rake Trim | Brown | Ready |
|  | SRT261400 | | 4 | 139" | 55.00 | PBR-Sculptured Rake Trim | Brown | Ready |
|  | SGU260500 | | 18 | 179" | 319.50 | PBR-Standard Gutter (1.12) | Brown | Partial Complete |
|  | SGU260500 | | 8 | 189" | 150.00 | PBR-Standard Gutter (2.12) | Brown | Ready |
|  | DPS264410S | | 14 | 20'11" | 292.83 | Downspout 4 x 4 *** (Straight)*** | Brown | In Production |

We created SWBuildNet to provide you with the best information of where your order is in the process so you can have accurate information to tell your customer!

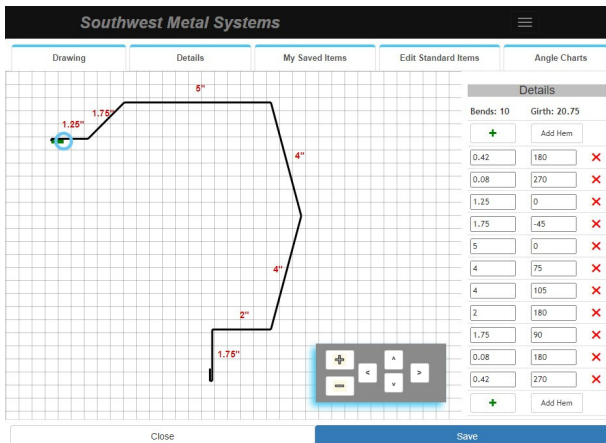

- Create and price custom trims
- Easily change colors on panels or trim
- See payment history
- Create and save component quotes
- Turn quotes into orders

Plus receive discounts for entering orders and paying online!

Discounts Received

\$21,865.61









Lifetime Discounts Received.

ENGINEERED BOLT UP BUILDINGS

- Meets local building codes
- In-house engineering
- QR codes loaded with erection details

WELD UP PACKAGES & COMPONENTS

-  Metal Panel
-  Cee Purlin
-  Zee Purlin
-  Girts
-  Insulation
-  Fasteners
-  Trim
-  Accessories

-  Vents & Skylights
-  Structural Steel
-  Residential Roofing
-  Residential Trim
-  Gutters
-  I-Beam
-  Doors & Windows
-  + and much more!

WELD UP PLUS

START STANDING STEEL AS SOON AS YOU PULL IT OFF THE TRAILER!

- Give your customer a cleaner finished product
- Rafters & columns cut to pitch & length
- Roof purlin clips pre-welded
- All steel cleaned & painted



Rigid lap edge for less kinks when handling



Less edge wave created by rollforming



Tighter seal and cleaner look

STANDARD TRIM PROFILES

Standard Rake

Item Number: SRT261400

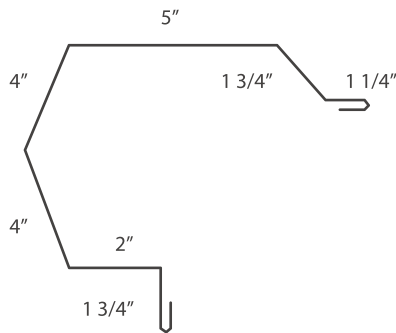

Box Rake

Item Number: BRT261410

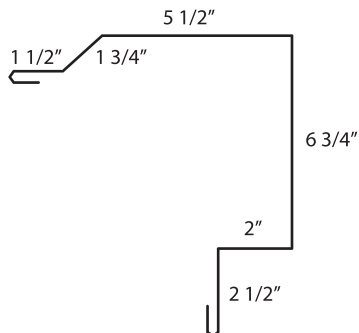

Tie In Trim (1:12)

Item Number: CTI26102

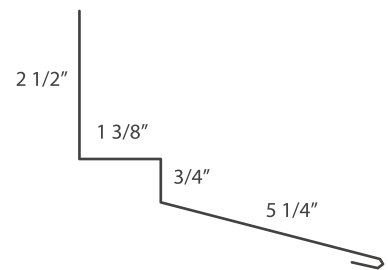

HiSide Eave (1:12)

Item Number: HSE260810

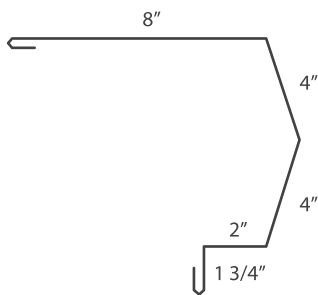

Long Eave Trim (1:12)

Item Number: LEA260820

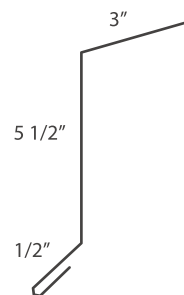

Utility Eave (1:12)

Item Number: See Below

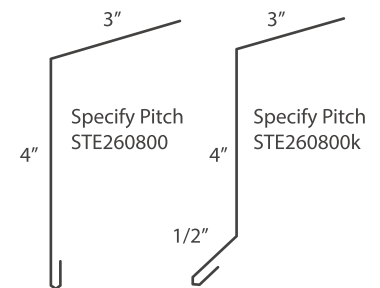

Inside Corner w/Hems

Item Number: ITC260130H

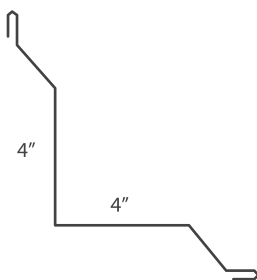

Outside Corner w/Hems

Item Number: OCT260160H

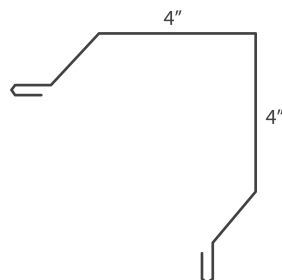

Head Trim

Item Number: See Below

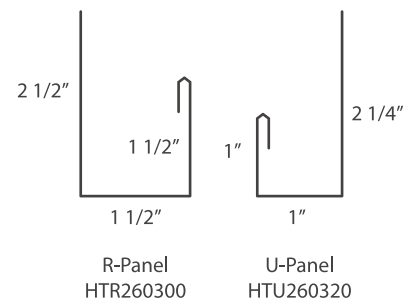

Sculptured Ridge

Item Number: RCS260010s

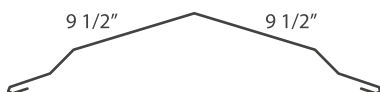

Ridge Roll

Item Number: RSR260200



Ridge Cap

Item Number: Select Size

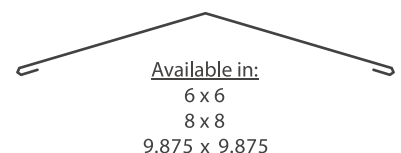

You can also build your own custom trim profile on SWBuildNet.com
Lengths up to 21'

Residential Gutter (1/2")

Item Number: RGU260501

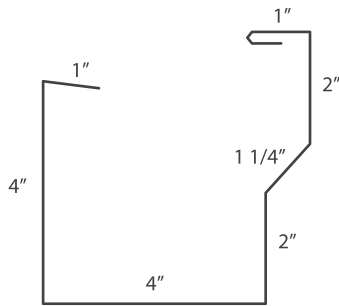

Standard Gutter (1/2")

Item Number: SGU260500

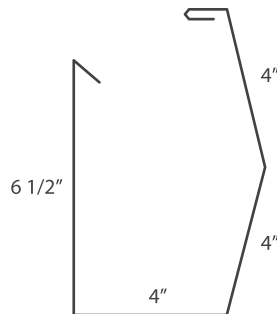

Downspout w/Kick

Item Number: DSP260010K

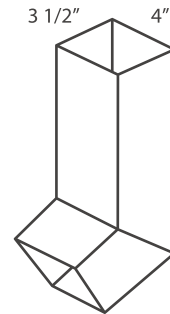

Jamb Trim

Item Number: See Below

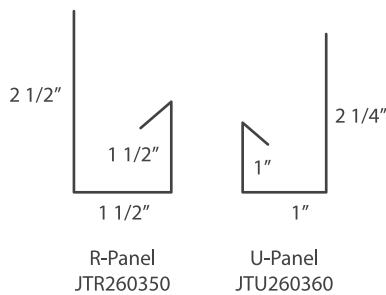

Inside Angle

Item Number: Select Size

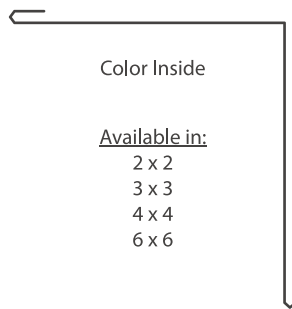

Outside Angle

Item Number: Select Size

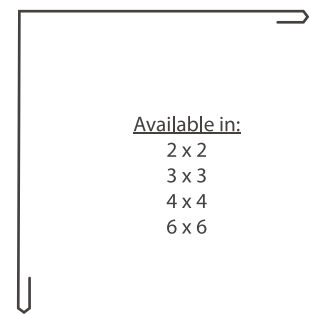

Wide Head Trim

Item Number: WHT260302

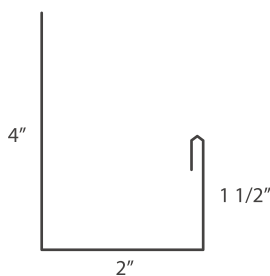

Drip Trim

Item Number: DTR260330

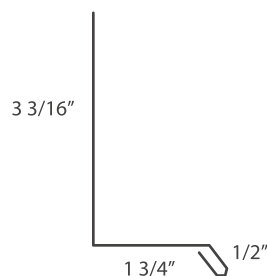

Sidewall Transition

Item Number: SWT261481

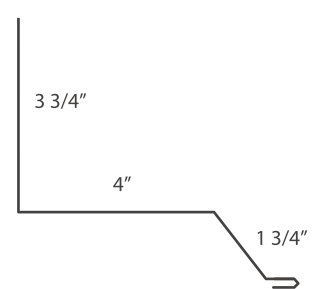

Valley Flashing

Item Number: VAL260540

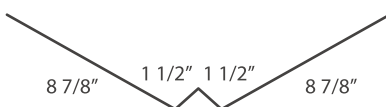

Pitch Change Transition

Item Number: PCT261486

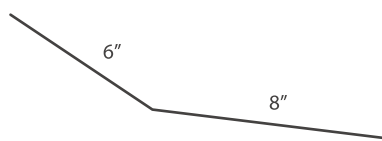

House Rake w/Kick

Item Number: HRR261490k

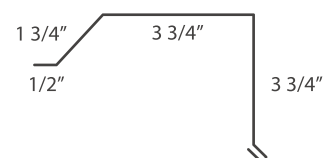

SOUTHWEST

STEEL BUILDINGS
METAL SYSTEMS

Mineola, TX
903-569-8811

Southwest-Metal.com



HOURS

MONDAY - FRIDAY
8AM - 5PM

LOCATION

485 NE LOOP 564
MINEOLA, TX 75773